

*Elements*<sup>®</sup>

PREMIUM VINYL WINDOWS AND DOORS



**SoftLite**<sup>®</sup>  
Windows & Doors



What Makes

*Elements Windows*

SECOND TO NONE?

---

Expertly manufactured by SoftLite Windows & Doors, the Elements line of premier vinyl replacement windows combines technology, engineering, and craftsmanship. Our world-class precision manufacturing makes Elements the highest-performing window in the industry.

Through intense research and testing, SoftLite's Elements line of windows far exceeds all industry standards for energy efficiency, air and water penetration, and durability.

When you purchase Elements windows, you not only help lower your energy bills but reduce your home's carbon footprint and support USA-made products.

Beyond profound efficiency, homeowners choose Elements windows because they are also secure and beautiful — enhancing your home's appearance and performance.





# The Elements Difference

Elements windows boast the best air infiltration and U-Factor numbers in the industry, which translates into tremendous energy efficiency and durability. The following are just some of the features that truly make Elements stand out above the competition:

## DURA-SILL™

This unique sill dam is mortised and welded into the jamb. It extends into the window with unique barriers and diversions to drastically reduce water buildup and provide supreme strength and seal — even under extreme wind-load stress.

## COMFORT-FOAM® R5 INSULATION

Environmentally friendly polyurethane foam fill in the frame and sash dramatically increases thermal efficiency to make your home more comfortable than typical R1 hollow frames.

## K-BEAM™ MEETING RAIL REINFORCEMENT

Available on double-hung and slider windows, this Kevlar®-enhanced feature is stronger than steel and more than 700 times warmer than aluminum for durability and efficiency.

## WARM-EDGE SUPER SPACER®

The only 100-percent foam, metal-free spacer is long-lasting, flexible, resists stress, prevents heat from escaping, and minimizes condensation. This durable spacer is up to 16° warmer than metal spacers and lasts 20 times longer than single-seal glass systems.

## EXCLUSIVE DUAL-ACTION INVISIBLE TILT HARDWARE SYSTEM (ILTIS®)

Enables easy, one-touch, tilt-in operation with no unsightly surface-mounted tilt latches.

## FUSED uPVC FRAMES AND SASHES

Our frames and sashes are made from the finest quality, long-lasting unplasticized material that never rots or corrodes and helps conserve energy. They will not separate and leak air or water.

## ENDURA-FORCE™ BALANCE SYSTEM

This Teflon®-coated AAMA Class 3 stainless coil is 3/4" and outperforms the 1/2" of the competitors, making for quiet ease of operation. Perfect for triple-pane glass.

## INNOVATIVE LIFETIME TRIPLE-FIN ULTRASMART™ WEATHERSTRIPPING

More than 600 inches of antimicrobial-protected weatherstripping on all frames and sashes provides extreme protection against drafts and air-borne bacteria, pollen, and mold.

## ELEGANT COVE MOLDING

Smooth corner seams and welds and a very tight tolerance of 1/32" give the detailed look of wood and help to reduce air leaks.



# ELEMENTS WINDOWS ARE CERTIFIED TO MEET THE INDUSTRY BEST STANDARDS. NO WINDOW CAN COMPETE WITH ITS OVERALL PERFORMANCE.



## ENERGY STAR®

Every year since 2014, SoftLite has been named an ENERGY STAR Partner of the Year and has earned the Sustained Excellence Award since 2016. This honor comes from manufacturing highly energy-efficient windows that positively impact the comfort and energy costs of homeowners as well as the environment. ENERGY STAR partners make outstanding contributions to protecting the environment through superior energy achievements in production, sale, and adoption of energy-efficient products, services, and strategies. Our windows are also on the ENERGY STAR Most Efficient Products list.

## NATIONAL FENESTRATION RATING COUNCIL (NFRC) RATINGS

The NFRC is a third-party nonprofit that administers the only uniform, independent rating and labeling system for the energy performance of windows and doors. NFRC labels on windows are specific to the window's overall thermal performance. The following are the rating definitions:

- **U-Factor** - The lower the number, the better the window's thermal performance.
- **Solar Heat Gain Coefficient** - How well products block heat caused by sunlight. The lower the number, the less solar heat is transmitted through the window.
- **Visible Transmittance** - How much light comes through the window — higher numbers are best.
- **Condensation Resistance** - How well the window resists condensation on glass. Again, a high number is better.

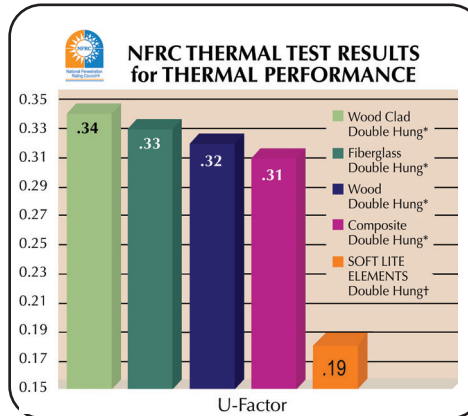

ENERGY STAR® Certified in Highlighted Regions		ENERGY STAR® Certified in Highlighted Regions	
energystar.gov/windows	■ Certified	energystar.gov/windows	■ Certified
VINYL CASEMENT ELEMENTS Triple Glazing, Argon Fill, Low-E		VINYL DOUBLE HUNG ELEMENTS Triple Glazing, Argon Fill, Low E	
<b>ENERGY PERFORMANCE RATINGS</b>		<b>ENERGY PERFORMANCE RATINGS</b>	
U-Factor (U.S./I-P)	Solar Heat Gain Coefficient	U-Factor (U.S./I-P)	Solar Heat Gain Coefficient
<b>0.18</b>	<b>0.20</b>	<b>0.19</b>	<b>0.22</b>
<b>ADDITIONAL PERFORMANCE RATINGS</b>		<b>ADDITIONAL PERFORMANCE RATINGS</b>	
Visible Transmittance	Condensation Resistance	Visible Transmittance	Condensation Resistance
<b>0.33</b>	<b>73</b>	<b>0.36</b>	<b>70</b>
<small>Manufacturer stipulates that these ratings conform to applicable NFRC procedures for determining whole product performance. NFRC ratings are determined for a fixed set of environmental conditions and a specific product size. NFRC does not recommend any product and does not warrant the suitability of any product for any specific use. Consult manufacturer's literature for other product performance information.</small>		<small>Manufacturer stipulates that these ratings conform to applicable NFRC procedures for determining whole product performance. NFRC ratings are determined for a fixed set of environmental conditions and a specific product size. NFRC does not recommend any product and does not warrant the suitability of any product for any specific use. Consult manufacturer's literature for other product performance information.</small>	

*Increased Performance*



## UNDERSTANDING AIR INFILTRATION

Air infiltration is a huge differentiator when it comes to the quality of windows. Windows leak air due to poor design and the absence of interlocks, weather-stripping, and barriers that keep air from forcing its way into your home between the sash meeting rails and perimeter. Without these features, air pushes between sash meeting rails and around the sash perimeter where it meets the frame and sill.

To ensure your comfort, we loaded the Elements windows with air and water barriers that far exceed the industry standard and other manufacturer's window designs. These windows leak only a fraction of typical windows leak.

## AAMA\* CERTIFICATION

The Fenestration and Glazing Industry Alliance's AAMA

Certification provides manufacturers with means to demonstrate product performance. The prestigious AAMA Gold label shows that products meet stringent performance standards by passing independent laboratory tests and follow-up on-site inspections. This is widely accepted as an indication of product quality.

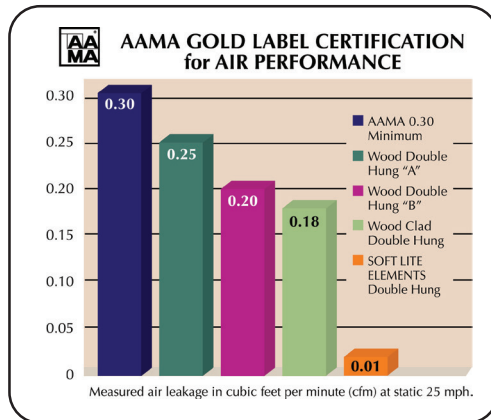

## AAMA PERFORMANCE RATINGS

AAMA Criteria	Industry Minimum	SoftLite Elements	RESULTS
AIR	.30	0.01	30x better
STRUCTURAL LOAD	94mph	203 mph (DP70)	>200% better

\*AAMA merged with IGMA into one organization - FGIA - Fenestration and Glazing Industry Alliance

# AIR INFILTRATION COMPARISON CHART

## INDUSTRY STANDARD

**.30 CFM**

of air leakage per minute



2.25 gallons of air per minute

## Traditional wood residential double-hung windows

**.23 CFM**

of air leakage per minute



1.725 gallons of air per minute

## Traditional vinyl residential high-performance double-hung windows

**.15 CFM**

of air leakage per minute



1.125 gallons of air per minute

*Elements*

**.01 CFM**

of air leakage per minute





0.075 gallons of air per minute

*Certified Excellence*

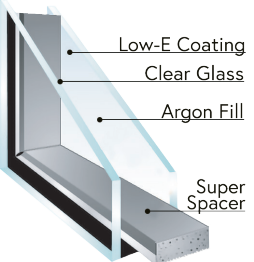
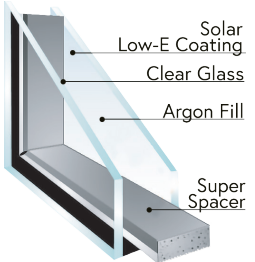
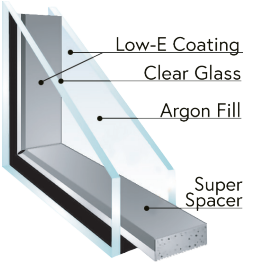
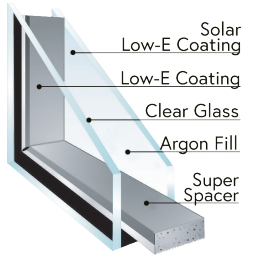
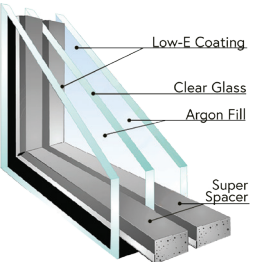
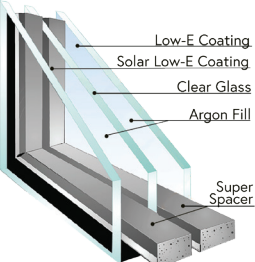

# Glass

SoftLite's technologically advanced insulated glass packages offer a choice of insulation performance that can be tailored to your geographic location and directional sun exposure. This ability to fine-tune your windows' performance assures maximum energy savings and resistance to condensation, which directly impacts your thermal efficiency, noise reduction, and fade protection. All Elements windows feature the warm-edge Super Spacer. Numbers below are for double-hung windows.

	<b>LOW-E GLASS</b> Double-pane, single-strength w/argon fill	<b>SOLAR LOW-E GLASS</b> Double-pane, single-strength w/argon fill	<b>THERMAL LOW-E GLASS</b> Double-pane, double-strength w/argon fill	<b>SOLAR THERMAL LOW-E GLASS</b> Double-pane, double-strength w/argon fill	<b>ULTRA-S LOW-E GLASS</b> Triple-pane, single-strength w/argon fill	<b>SOLAR ULTRA-S LOW-E GLASS</b> Triple-pane, single-strength w/argon fill
						
<b>IGU Thickness</b>	<b>7/8"</b>	<b>7/8"</b>	<b>7/8"</b>	<b>7/8"</b>	<b>1"</b>	<b>1"</b>
<b>U-Factor</b>	<b>0.26</b>	<b>0.26</b>	<b>0.22</b>	<b>0.22</b>	<b>0.19</b>	<b>0.19</b>
<b>SHGC</b>	<b>0.26</b>	<b>0.20</b>	<b>0.22</b>	<b>0.18</b>	<b>0.22</b>	<b>0.18</b>
<b>Visible Transmittance</b>	<b>0.48</b>	<b>0.46</b>	<b>0.38</b>	<b>0.42</b>	<b>0.36</b>	<b>0.34</b>
<b>Condensation Resistance</b>	<b>58</b>	<b>58</b>	<b>49</b>	<b>46</b>	<b>70</b>	<b>70</b>
	-	<b>South-Central Southern</b>	<b>All climate zones</b>	<b>All climate zones</b>	<b>All climate zones</b>	<b>All climate zones</b>
	-	-	-	<b>Southern</b>	<b>North-Central South-Central Southern</b>	<b>All climate zones</b>



The following energy-efficient options feature Super Spacer and are ENERGY STAR qualified. NFRC window labels refer to whole-window performance, not center -of-glass or just the insulated glass unit.

### SOLAR LOW-E GLASS

ENERGY STAR® Certified in Highlighted Regions

energystar.gov/windows ■ Certified

NFRC National Fenestration Rating Council®

SoftLite Windows & Doors

**VINYL DOUBLE HUNG ELEMENTS**  
Double Glazing. Argon Fill. Solar Low E

ENERGY PERFORMANCE RATINGS	
U-Factor (U.S./I-P)	Solar Heat Gain Coefficient
<b>0.26</b>	<b>0.20</b>
ADDITIONAL PERFORMANCE RATINGS	
Visible Transmittance	Condensation Resistance
<b>0.46</b>	<b>58</b>

Manufacturer stipulates that these ratings conform to applicable NFRC procedures for determining whole product performance. NFRC ratings are determined for a fixed set of environmental conditions and a specific product size. NFRC does not recommend any product and does not warrant the suitability of any product for any specific use. Consult manufacturer's literature for other product performance information. www.nfrc.org

### THERMAL LOW-E GLASS

ENERGY STAR® Certified in Highlighted Regions

energystar.gov/windows ■ Certified

NFRC National Fenestration Rating Council®

SoftLite Windows & Doors

**VINYL DOUBLE HUNG ELEMENTS**  
Double Glazing. Argon Fill. Thermal Low E

ENERGY PERFORMANCE RATINGS	
U-Factor (U.S./I-P)	Solar Heat Gain Coefficient
<b>0.22</b>	<b>0.22</b>
ADDITIONAL PERFORMANCE RATINGS	
Visible Transmittance	Condensation Resistance
<b>0.38</b>	<b>49</b>

Manufacturer stipulates that these ratings conform to applicable NFRC procedures for determining whole product performance. NFRC ratings are determined for a fixed set of environmental conditions and a specific product size. NFRC does not recommend any product and does not warrant the suitability of any product for any specific use. Consult manufacturer's literature for other product performance information. www.nfrc.org

### SOLAR THERMAL LOW-E GLASS

ENERGY STAR® Certified in Highlighted Regions

energystar.gov/windows ■ Certified

NFRC National Fenestration Rating Council®

SoftLite Windows & Doors

**VINYL DOUBLE HUNG ELEMENTS**  
Double Glazing. Argon Fill. Solar Thermal Low E

ENERGY PERFORMANCE RATINGS	
U-Factor (U.S./I-P)	Solar Heat Gain Coefficient
<b>0.22</b>	<b>0.18</b>
ADDITIONAL PERFORMANCE RATINGS	
Visible Transmittance	Condensation Resistance
<b>0.42</b>	<b>46</b>

Manufacturer stipulates that these ratings conform to applicable NFRC procedures for determining whole product performance. NFRC ratings are determined for a fixed set of environmental conditions and a specific product size. NFRC does not recommend any product and does not warrant the suitability of any product for any specific use. Consult manufacturer's literature for other product performance information. www.nfrc.org

### ULTRA-S GLASS

ENERGY STAR® Certified in Highlighted Regions

energystar.gov/windows ■ Certified

NFRC National Fenestration Rating Council®

SoftLite Windows & Doors

**VINYL DOUBLE HUNG ELEMENTS**  
Triple Glazing. Argon Fill. Low E

ENERGY PERFORMANCE RATINGS	
U-Factor (U.S./I-P)	Solar Heat Gain Coefficient
<b>0.19</b>	<b>0.22</b>
ADDITIONAL PERFORMANCE RATINGS	
Visible Transmittance	Condensation Resistance
<b>0.36</b>	<b>70</b>

Manufacturer stipulates that these ratings conform to applicable NFRC procedures for determining whole product performance. NFRC ratings are determined for a fixed set of environmental conditions and a specific product size. NFRC does not recommend any product and does not warrant the suitability of any product for any specific use. Consult manufacturer's literature for other product performance information. www.nfrc.org

### SOLAR ULTRA-S GLASS

ENERGY STAR® Certified in Highlighted Regions

energystar.gov/windows ■ Certified

NFRC National Fenestration Rating Council®

SoftLite Windows & Doors

**VINYL DOUBLE HUNG ELEMENTS**  
Triple Glazing. Argon. Solar Low E/Low E

ENERGY PERFORMANCE RATINGS	
U-Factor (U.S./I-P)	Solar Heat Gain Coefficient
<b>0.19</b>	<b>0.18</b>
ADDITIONAL PERFORMANCE RATINGS	
Visible Transmittance	Condensation Resistance
<b>0.34</b>	<b>70</b>

Manufacturer stipulates that these ratings conform to applicable NFRC procedures for determining whole product performance. NFRC ratings are determined for a fixed set of environmental conditions and a specific product size. NFRC does not recommend any product and does not warrant the suitability of any product for any specific use. Consult manufacturer's literature for other product performance information. www.nfrc.org

### ENERGY STAR 7.0 MAP AND CRITERIA

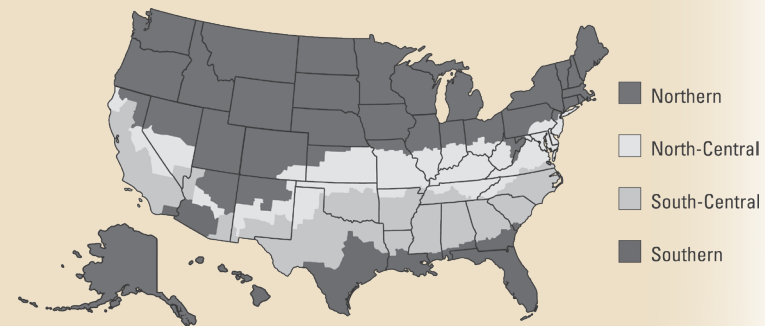

WINDOWS			
Climate Zone	U-Factor <sup>1</sup>	SHGC <sup>2</sup>	
Northern	≤ 0.22	≥ 0.17	Prescriptive
	= 0.23	≥ 0.35	
	= 0.24		
	= 0.25		
	= 0.26	≥ 0.40	
North-Central	≤ 0.25	≤ 0.40	
South-Central	≤ 0.28	≤ 0.23	
Southern	≤ 0.32	≤ 0.23	

Air Leakage ≤ 0.3 cfm/ft<sup>2</sup>  
<sup>1</sup> Btu/h-ft<sup>2</sup>-F  
<sup>2</sup> Solar Heat Gain Coefficient

Ultimate Energy Efficiency



# Best in Class

## SUPER SPACER®

This revolutionary TrueWARM® spacer system outperforms all others. The world's only 100 percent foam sealing system blocks heat and provides one of the best thermal performance in the industry. Unlike metal spacers, this system is flexible and resists the stress from seasonal weather changes. The less metal there is, the lower the U-Factor, and the more energy you save.

- The Super Spacer boasts a proprietary multi-layer vapor barrier and structural adhesive combined with a perimeter-edge sealant for dual-seal durability. This feature separates the glass and drastically reduces the transfer of cold conduction through the glass unit.
- This warm edge works to **minimize condensation** and allow for comfortable household humidity levels. Condensation is unsightly and can lead to stained wood, peeling paint, rotted frames, mold growth.
- The P-1 durability test shows the dramatic difference Super Spacer makes to the longevity of your insulated glass system. The P-1 is the world's toughest durability test, exposing units to 140°, 95-100% humidity and constant UV bombardments. Each week of testing equals one year of actual field use.

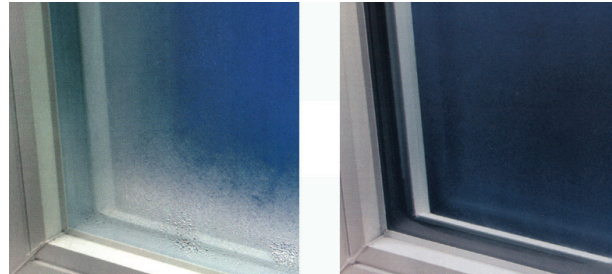

Full-metal spacer

Metal-free Super Spacer

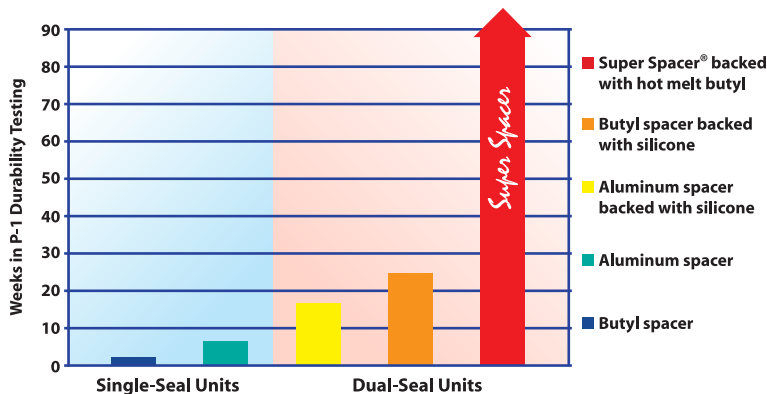

Up to 16.6° warmer temperatures at the edge of the glass compared to metal spacers

20 times the life expectancy of single-seal insulating glass systems

## LIFETIME WARRANTY

The Elements industry-leading Lifetime Warranty protects both your investment and our reputation. SoftLite guarantees its windows will not rot, rust, warp, pit, corrode, or blister. Additionally, our colors will remain true for the life of your home. This warranty is non-prorated, fully transferable, and covers all moving parts and hermetically insulated seal against defects in materials or workmanship. We also offer the ultimate protection with a lifetime glass breakage rider for extra peace of mind.

## BETTERVUE® SCREENS

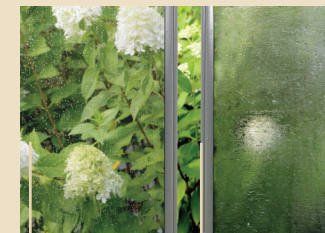

These high-definition fiberglass screens are standard on Elements. BetterVue screens preserve optical clarity by shedding water and resisting

dirt for a clearer outward view, improve light transmittance, provide greater airflow, and increase insect protection. The extruded frames will never hourglass, which keeps the screens taut. In addition, these screens lock for increased security.

Casements feature hidden retention hardware to eliminate unattractive screen clips.

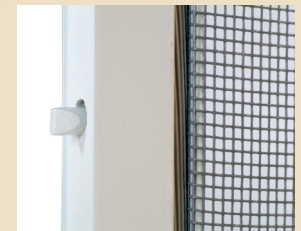

# Durability

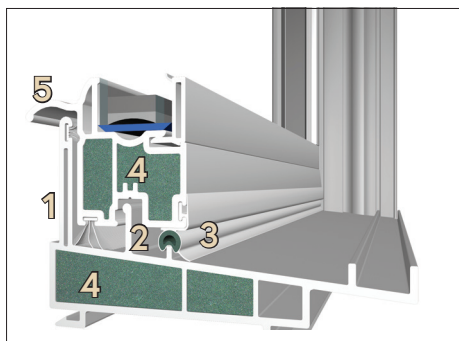

## DURA-SILL — ONE-OF-A-KIND SILL DESIGN

- 1) The double-walled sill dam extends into the window jamb for unmatched strength and seal, nearly eliminating water buildup.
- 2) Our structural interlocking sill-sash rail keeps the sash in place against the weatherstrip under extreme wind-load stress.
- 3) The Foam-Tite polyurethane foam compression gasket and rail system straddles the sill rails when the sash is locked to add barriers and diversions for impressive air and water resistance.
- 4) Environmentally friendly Comfort Foam insulation fills cavities of the sash and sill extrusion for increased thermal efficiency, lower emissions, and better conservation.
- 5) Integral lift rails are part of the profile — not in the glazing bead, which can work loose over time or pop out like other lift rails.

This system combines the sash, interlocks, water barriers, weatherstripping, and diversions to maximize energy efficiency.

*Purchasing a window without insulation is like buying a refrigerator without insulation*



## TEFLON®-COATED ENDURA-FORCE™ BALANCE SYSTEM

This innovative feature ensures quiet, maintenance-free, smooth operation for the lifetime of your windows. This heavy-duty constant force balance system uses a 3/4" steel band that is much stronger than the standard 1/2" block and tackle system. Endura-Force provides excellent support for heavier triple-pane sashes, and the thermally engineered housing further improves thermal value.

## K-BEAM™ COMPOSITE SASH KEEPER RAIL

Elements double-hung and slider windows are reinforced with K-Beam — a unique composite material that incorporates Kevlar® fibers for additional strength and durability, low thermal conductivity, and extra energy efficiency. This material is stronger than aluminum or steel and is 700 times warmer than aluminum!

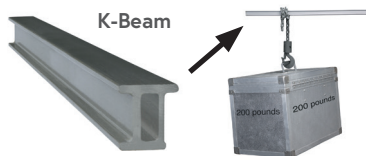
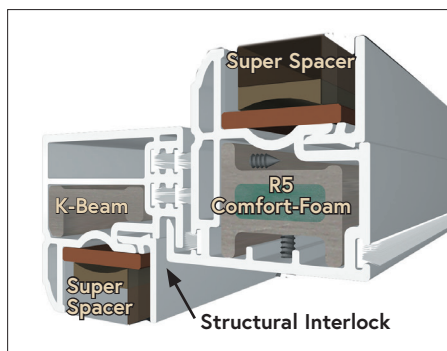

## DEPENDABILITY

Double-hung and slider windows come with two dual-action, low-profile locks that provide a clean sightline and pass the stringent AAMA Gold Forced Entry Resistance certification for structural integrity, safety, and security.

Casement locks include low-profile, corrosion-resistant steel and nylon locking rollers that engage sash keepers to ensure a secure, weather-tight seal. Multi-point locks engage with matching sash keepers with a single-lever.

Our revolutionary hooded keepers absorb impact, distribute the load, and protect the glazing leg of the keeper sash rail.

Easy-to-use, low-profile vent latches limit how far the sashes open. Windows can still be vented but limited to help prevent entry.

Additionally, the Elements BetterVue screens feature locks on the frames.





**Double-hung windows** are the most popular style of windows and feature two moving sashes with integral lift rails that are sturdy and easy to use. The encapsulated tilt latch hardware enables one-touch operation and allows for easy cleaning. Our Endura-Force balancers ensure smooth movement that never needs adjusting. The unique design of the hooded keeper provides a sleek look and allows for easy maintenance and adjustments. *Available in standard, cottage, or oriel styles.*

# Double-Hung's



STANDARD COTTAGE ORIEL



Vent latches are simply deployed and limit sash travel.



Both sashes open and tilt in for easy ventilation and cleaning



Endura-Force 3/4" Teflon-coated, stainless steel balancer features a thermally engineered housing for increased energy efficiency and provides quiet, effortless operation

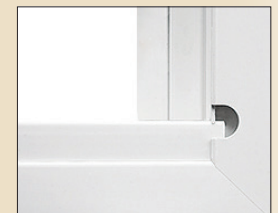

Tight, mortised-cut, double-wall sill dam extends inside the jamb, increasing durability and eliminating an open seam joint.



**Slider windows** are basically double-hung windows on the side and without the balancers. This style slides horizontally from side to side and offers an unobstructed view and a selection of operating choices. Ideal for smaller spaces or difficult-to-reach windows.

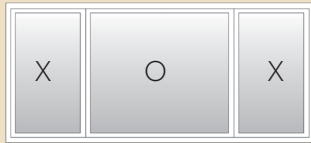
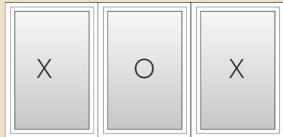

Available in 2-lite and 3-lite sliders.  
"X" designates operating lites and "O" designates fixed lites.



Each Elements window (except case-ments) features 600" of weather-stripping on the frames, sashes, and interlocking meeting rails with built-in Ultra-Fresh antimicrobial protection to minimize drafts, dust, and pollen and fight the growth of mold and bacteria.

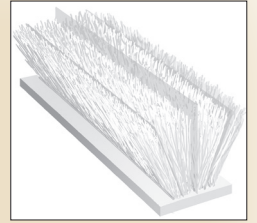

All slider sashes roll on corrosion-resistant double brass rollers that provide smooth, effortless operation to easily glide to open and close.



Low-profile lock and keeper provide a clean sightline through the window on sliders.







*Casements*  
*Awnings and Hoppers*

Form and function. Order this versatile style individually or as part of a bay or bow. Designed with the clean lines of a picture window, **casements** offer the added ventilation and freedom of opening the sash to the outdoors.

The single-lever fold-down lock handle engages easily and has multiple lock points for security. The durable cranks and hardware ensure effortless operation. Plus, these windows open a full 90 degrees for easy cleaning. Elements casement windows are AAMA Gold Label certified and boast the best NFRC-rated U-Factor in the industry. *Egress hardware is optional. Available in 2-, 3-, and 4-lites.*



AWNING



HOPPER

**Awning** windows are hinged at the top and crank outward to open. **Hopper** windows hinge at the bottom and pull inward to open.

*Awnings are available in horizontal or vertical configurations.*







# Shapes and Pictures

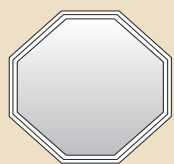

Octagon



Hexagon

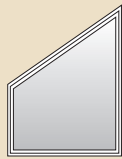

Trapezoid



Ang Pentagon

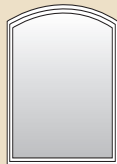

Archtop



Peak Pentagon

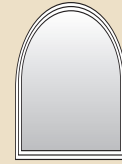

Circle Top

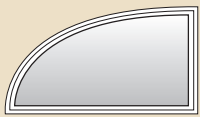

Partial Elliptical

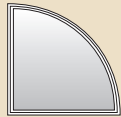

Quarter Round



Full Circle



Half Eyebrow EL



Eyebrow

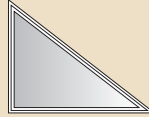

Right Triangle



For special openings and accents, we offer a variety of **shapes**. All special shapes are custom-built to your specifications. The illustrations to the left are just a sampling of the available types. *Standard shapes are made using low-profile material due to geometric bends.*

**Picture windows** are large, fixed-lite (non-operational\*) windows designed to give you a clear view of your surroundings without any obstructions. *Available in most shapes and sizes.*

*\* Certain-sized octagons are available as operable units.*



Open up your living space by adding top-of-the-line 3-D depth and light that provides improved energy efficiency, maintenance-free durability, and increased ventilation.

**Bow** windows appear more rounded as they are comprised of windows at a 10° or 15° angles.

**Bay** windows are window combinations that extend outward from the home at either 30° or 45° angles. We offer many features that other manufacturers charge for or omit:

- 1¼" thick furniture-grade laminated hardwood seat, head, and side jambs
- R-9 Super-Seat with high-density material to ward off condensation and energy loss
- Steel-reinforced, ComfortFoam-filled mullions and frames
- Available in picture, double-hung, and casement models
- Plus, we pay special attention to prevent windows from snagging over time, such as threaded rods in the mullions, and a chain and turnbuckle support system to ensure stability.

# Bows and Bays

BOW



BAY

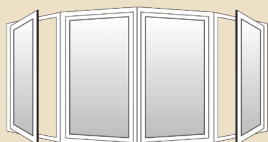

4-lite Bow 10° and 15°

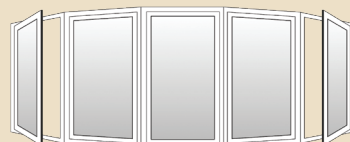

5-lite Bow 10°

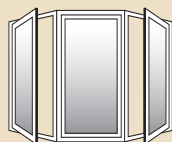

3-lite Bay 10°, 15°, 30°, 45°

EXTERIOR VIEWS











## DECORATIVE GRIDS

We offer grids in all interior and exterior colors to color match your home. Choose from countless configurations. Ask your dealer representative for types and availability.



*Simulated divided lite (SDL) grids provide the look of separate panes of glass set into the grid. Ideal for historic homes. Not available on triple-pane glass*

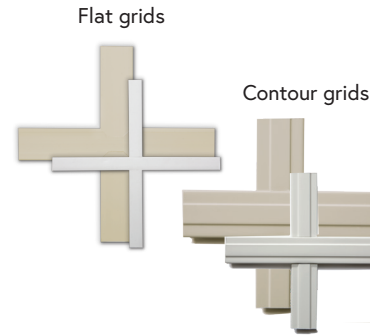

*Flat and contour grids are between the airspace and are entirely dust-free. Available in wide or standard width. Some grid styles are only available with flat grids. Pencil grids also available.*

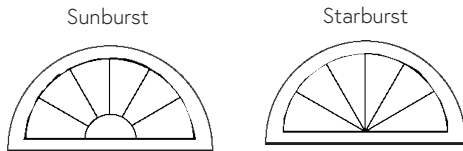

*Grids are available in all colors and wood grains. This is a sampling, several grid patterns are available. Grid pattern availability and appearance is based on window size and shape. Wide widths are only available in white and beige.*

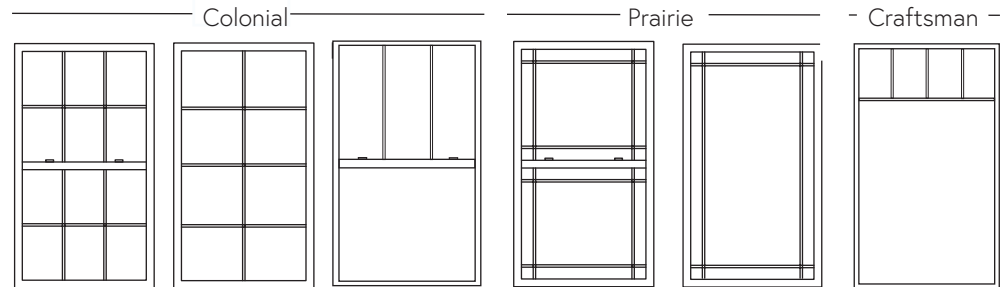

## HARDWARE FINISH CHOICES

We offer a selection of quality handles and locks in a variety of finishes to suit your preferences. Our standard recessed lock provides a sleek, low-profile appearance that offers enhanced beauty, exceptional strength, and security. The casement lock folds flat.



## COLORS

We have the colors to complement any decor. Choose from a wide variety of interior or exterior color options. With SoftLite's Sure-Coat custom color-matching system, a truly color-matched house is now a reality. The possibilities are endless. *Please see your dealer representative for precise color representations.*

### INTERIOR CHOICES

#### Vinyl



The beautiful satin finish of Soft-White vinyl is preferred over standard white windows.

#### Wood Grains



### EXTERIOR CHOICES

#### Vinyl

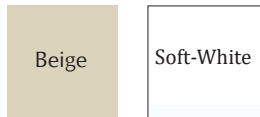

#### Delta-E Exterior Foil Laminate

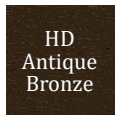

This reflective laminate exceeds Sure-Coat in longevity.

#### Delta-E Exterior/Interior Foil Laminate

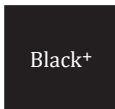

Black laminate is only available with interior black laminate and vice versa.

#### Sure-Coat™ PVC Bond Colors

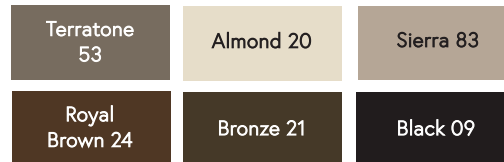

Sure-Coat color is warranted for 10 years. Additional custom colors are available to match any exterior. Contact your SoftLite dealer for details.

*Actual color samples may vary from printed brochure. See your SoftLite dealer for more precise color representations. All exterior colors should be viewed in outside daylight.*

Custom colors are available for a small fee. Sure-Coat is warranted for 10 years.

**+ Black laminate is only available as a combination - interior and exterior**  
**Bays and bows are not available in black laminate**

### FLEXSCREEN®

Optional FlexScreen is a cutting-edge, PVC-coated, high-performance spring steel frame that hides in the window screen pocket, appearing invisible and improving sightlines. *Optional on select double-hungs and sliders. Standard on units with exterior bond colors (laminates).*



### DECORATIVE GLASS

Our obscure glass provides privacy while illuminating your room.

We also offer bronze- or gray-tinted glass. Leaded glass designs are also available - speak with your representative.



RAIN

STANDARD



# *The Ultimate Pairing of Function and Beauty*

The benefits of furnishing your house with Elements windows are endless. Fade protection, noise reduction, ease of cleaning, security, beauty, and the peace of mind knowing that your investment is made in the USA by SoftLite, a manufacturer with 90 years of experience.

## FADE PROTECTION

Solar Ultra Glass provides fade protection for all of your home furnishings and artwork. UV light is responsible for up to 40 percent of fading damage. Protecting your items with Solar Ultra Glass blocks 94 percent of all harmful ultraviolet light.



## NOISE REDUCTION

Sound, like air, always takes the path of least resistance. Noise travels via air and materials. A tight-fitting window frame manufactured to significantly reduce air infiltration will also help to deaden sound, which makes the Elements windows an ideal choice with its high-quality weatherstripping and quality locks and latches. Other items to keep in mind for noise reduction:

- Number of panes – double-pane windows will help reduce the amount of noise better than single-paned windows, and triple-pane windows are even more effective. Sound waves are absorbed, reflected, or minimized with each pane of glass.
- Types of glass – the window's sound transmission is reduced further when you choose laminated glass or double-strength glass as it helps to dampen the sound.
- Proper installation - this important step helps ensure airtight seals as well as works to reduce noise. Elements installers are specially trained, so you know they are installed correctly by experts.

Enjoy the sounds of nature when you effortlessly open your beautiful windows but relish the quieter environment when your Elements windows are closed.



# Not Your Traditional Windows

## EASE OF CLEANING

Elements windows are virtually maintenance-free and a breeze to clean. Just wipe frames and sashes with a soft cloth or soft-bristled brush.

- Our double-hung windows easily tilt in to easily clean inside and out.
- Casement windows open to 90° so homeowners can reach between the sash and the frame to clean both inside and outside of the sash.
- The sashes on slider windows lift out for easy accessibility to both sides.



demanding criteria, which still holds true to this day.

When manufacturing Elements windows in our facility in Streetsboro, Ohio, we utilize technological advancement to develop the most energy-efficient and durable products available. Our precision machine processing helps to minimize risk and maximize quality. It is this quality and attention to detail that has earned SoftLite numerous awards over the years, including *Window & Door Magazine's* Top 100 Manufacturers and Crystal Achievement awards.



## SECURITY

Rest easy knowing our intruder-resistant Elements windows meet or exceed all AAMA Forced-Entry Resistance Testing and American Society for Testing and Materials Specification (ASTM) break-in Resistance Standards.

## ABOUT SOFTLITE

SoftLite began manufacturing Elements windows to build a window for a whole new generation. The company wanted to offer the highest-performing, most attractive replacement windows on the market. SoftLite completely re-designed the ultimate window as no conventional window designs met its





# Elements<sup>®</sup>

*Unsurpassed overall performance. Unparalleled quality. Unequaled beauty. Undeniably ... the best!*

Congratulations. You are working with a dealer deemed one of the best in the business. We hold our exclusive Elements dealers to the same standards as our windows. Each authorized Elements dealer is selected based on stringent criteria and exacting standards such as integrity, product knowledge, professional installation, and stellar customer service. In addition, our partners have impeccable reputations and impressive showrooms. All Elements go through an intensive training program.



**Authorized Dealer**